

门底自动密封条是为了密封门底与地面或门槛之间的缝隙而设计的，当门打开时，密封条会自动升高地面，当门关闭时，密封条会自动降下来，起到密封作用，隐藏式的设计不影响门的外观，不妨碍门的开与关，也不会磨损地面。适用于木质门、金属门、钢木门的门底安装，可起到隔音、隔温、挡尘的效果。

The automatic bottom door seal is to seal the gap between the bottom of the door and the ground or the threshold of the design, when the door is opened, the seal will automatically rise from the ground, when the door is closed, the seal will automatically drop down, plays a role in sealing, the hidden design does not affect the appearance of the door, do not interfere with the door open and, don't wear the ground. The utility model is suitable for the installation of the wooden door, the steel door and the steel door, and can play the functions of sound insulation, temperature isolation and dust control



门底自动密封条--D1 & D11隐藏系列

Auto hide dustproof strip for door bottom--D1 & D11 series

主要适用范围:

适用于木质门、金属门、钢木门……

标准配置:

1根防尘条、配件包可选配件包1或者配件包3, 或无配件(调整钮可选铜头)

安装方法:

将自动门底密封条嵌入槽中, 两边顶端用随附包装所提供的固定挡片固定

Main application:

Suitable for wooden door, metal door, steel door……



Standard configuration:

1 dust bars, accessories package optional accessories package 1 or accessories package of 3, or spare parts (adjustable button optional copper head)

Installation method:

The automatic door bottom sealing strip is embedded in the groove, and both sides of the top end are fixed with the fixed retaining plate provided by the accompanying package

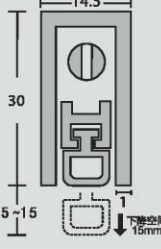
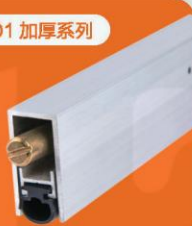
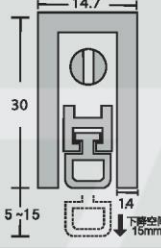
单位: mm

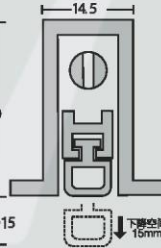
型号 Item NO.	实物图 Material object	剖面图 Profile	品号 Product No.	适用门片的规格 Specification for door panels	长度范围 length	密封材质 Sealing material	封堵缝隙 Sealing Gap
D1 系列			D1-25 D1-66 D1-85 D1-100 D1-120 D1-150 D1-185	250~330 330~660 660~850 660~1000 1000~1200 1200~1500 1500~1850	250~1850 (可截取任意长度) Interception Arbitrary length	PVC TPE	15 以内
D1 加厚系列			D1-25H D1-66H D1-85H D1-100H D1-120H D1-150H D1-185H	250~330 330~660 660~850 660~1000 1000~1200 1200~1500 1500~1850	250~1850 (可截取任意长度) Interception Arbitrary length	PVC TPE	15 以内
D11 系列			D11-25 D11-66 D11-85 D11-100 D11-120 D11-150 D11-185	250~330 330~660 660~850 660~1000 1000~1200 1200~1500 1500~1850	250~1850 (可截取任意长度) Interception Arbitrary length	PVC TPE	15 以内



Accessories-1 配件包-1



Accessories-3 配件包-3

材质: 304 不锈钢 / SPCC 铁镀镍
Material: 304 stainless steel / SPCC iron plating



提示: 产品的外型、尺寸、颜色可根据客户需要定做

建议: 与门框密封条一起使用, 更可节约能源及防冷、暖气外流

Special note: product appearance, size, color can be customized according to customer needs

Note: The utility model can be used together with a door frame sealing strip, and the utility model can save energy and prevent cold and heat from flowing out

门底自动密封条--D17 & D18静音隐藏系列

Auto hide dustproof strip for door bottom--D17 & D18 Silent series

**专利
新品**

主要适用范围:

适用于木质门、金属门、钢木门……

标准配置:

1 根防尘条 (调整钮纯铜头)、
配件包可选 304 不锈钢或 SPCC 铁镀镍

安装方法:

将自动门底密封条嵌入槽中,
两边顶端用随附包装所提供的固定挡片固定

Main application:

Suitable for wooden door, metal door, steel door……



Standard configuration:

1 dust bars, accessory kit optional 304 stainless steel or SPCC iron nickel-plated

Installation method:

The automatic door bottom sealing strip is embedded in the groove,
and both sides of the top end are fixed with the fixed retaining plate provided
by the accompanying package

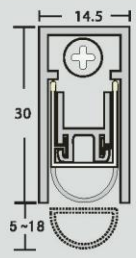
单位: mm

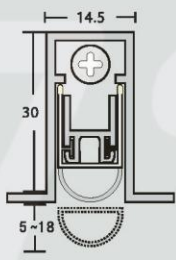
型号 Item NO.	实物图 Material object	剖面图 Profile	品号 Product No.	适用门片的规格 Specification for door panels	长度范围 length	密封材质 Sealing material	封堵缝隙 Sealing Gap
D17 系列			D17-50	340-500	340~1500 (可截取任意长度) Interception Arbitrary length	橡塑共挤 Rubber co-extrusion	18 以内
			D17-65	500-650			
			D17-85	650-850			
			D17-100	850-1000			
			D17-120	1000-1200			
			D17-135	1200-1350			
D17-150	1350-1500						
D18 系列			D18-50	340-500	340~1500 (可截取任意长度) Interception Arbitrary length	橡塑共挤 Rubber co-extrusion	18 以内
			D18-65	500-650			
			D18-85	650-850			
			D18-100	850-1000			
			D18-120	1000-1200			
			D17-135	1200-1305			
D17-150	1305-1500						



Accessories-3 配件包-3

标配配件

Marking accessories:

材质: 304 不锈钢 / SPCC 铁镀镍

Material: 304 stainless steel/SPCC iron plating

标配

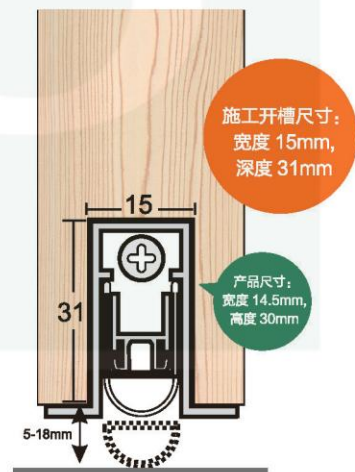

提示: 产品的外型、尺寸、颜色可根据客户需要定做
建议: 与门框密封条一起使用, 更可节约能源及防冷、暖气外流
Special note: product appearance, size, color can be customized according to customer needs
Note: The utility model can be used together with a door frame sealing strip, and the utility model can save energy and prevent cold and heat from flowing out



门底自动密封条--D16隐藏系列

Auto hide dustproof strip for door bottom--D16 series

主要适用范围:

适用于木质门、金属门、钢木门……

标准配置:

1根防尘条、配件包
(不锈钢档片2片, 不锈钢螺丝*2)

安装方法:

将自动门底密封条嵌入槽中,
两边顶端用随附包装所提供的固定挡片固定

Main application:

Suitable for wooden door, metal door, steel door……

Standard configuration:

1 dust bars, accessories package (stainless steel 2 pieces, stainless steel screws *2)

Installation method:

automatic door bottom sealing strip embedded in the groove, both sides of the top with the accompanying packaging provided by fixed retaining plate fixed

单位: mm

型号 Item NO.	实物图 Material object	剖面图 Profile	品号 Product No.	适用门片的规格 Specification for door panels	长度范围 length	密封材质 Sealing material	封堵缝隙 Sealing Gap
			D16-50	385-500			
			D16-65	500-650			
			D16-80	650-800	385-950	TPE	15以内
			D16-95	800-950			

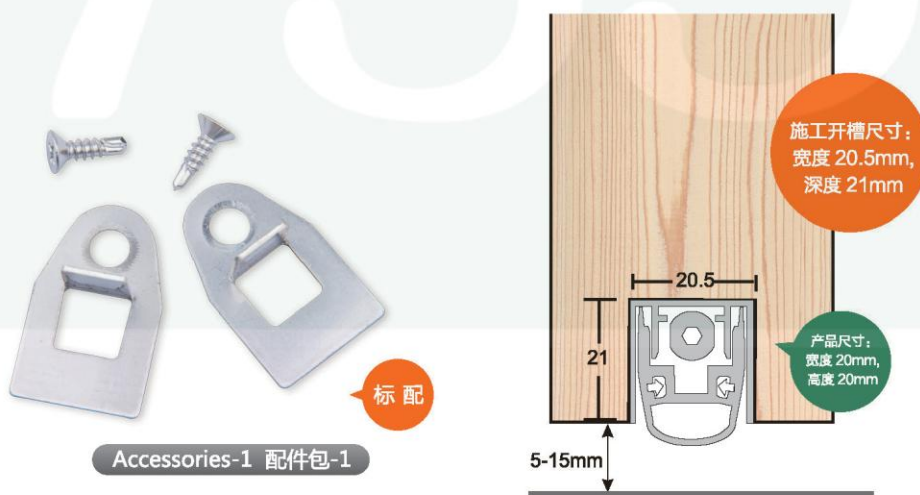

提示: 产品的外型、尺寸、颜色可根据客户需要定做

建议: 与门框密封条一起使用, 更可节约能源及防冷、暖气外流

Special note: product appearance, size, color can be customized according to customer needs

Note: The utility model can be used together with a door frame sealing strip, and the utility model can save energy and prevent cold and heat from flowing out

门底自动密封条--D12隐藏系列

Auto hide dustproof strip for door bottom--D12 series

主要适用范围:

适用于木质门、金属门、钢木门……

装饰盖颜色:

白色, 咖啡色, 红棕色、灰色

安装方法:

需在门底中间加工一条 10.5mmX19mm 的嵌槽, U 型铝型材固定在槽中, H 型插入 U 型材中左右装饰盖盖紧, 调整钮至理想位置

Main application:

Suitable for wooden door, metal door, steel door……

Decorative cover color:

white, brown, red brown, gray

Installation method:

to insert groove intermediate processing a 10.5mmX19mm at the bottom of the door, U type aluminum profile is fixed in the groove, H insertion of U profiles, or decorative cover tightly, the adjusting knob to the desired position

单位: mm

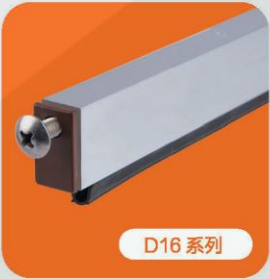
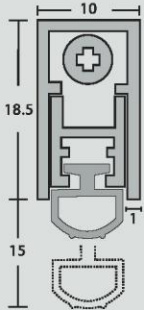
型号 Item NO.	实物图 Material object	剖面图 Profile	品号 Product No.	适用门片的规格 Specification for door panels	长度范围 length	密封材质 Sealing material	封堵缝隙 Sealing Gap
			D12-71	520~710	520~1200 (可截取任意长度) Interception Arbitrary length	TPE	15 以内
			D12-90	710~900			
			D12-120	900~1200			



Accessories-1 配件包-1

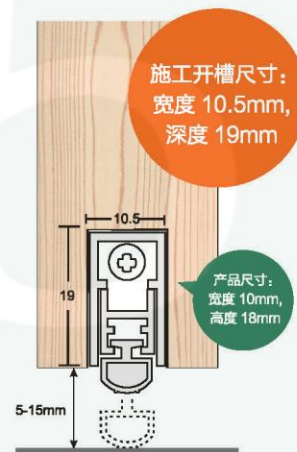

外贴刮板--D10系列

Scraper for Door bottom

主要适用范围:

室内门、钢制门、纱窗门、推拉门……

标准位置:

可在门的底部外侧或内侧或推拉门的周边安装

安装方法:

自带胶，直接粘贴也可以用螺钉安装。
按门(窗)的宽度截锯密封胶条

材质:

采改性 PVC 材质，利用软、硬共挤制成后
加发泡 PE 背胶

特性:

附强力背胶、施工方便、不易脱落。
填满门(窗)缝 --- 节约能源

Main application:

indoor doors, steel doors, screen doors, sliding doors.....

installation position:

can be installed on the outside or inside of the door or
theperiphery of the sliding door

installation:

With glue, can also be used directly to install screws.
Cut the sealing strip according to the width of the door (window)

Material:

adopt modified PVC material, the use of soft and hard coextrusion
made after adding foaming adhesive PE

Characteristics:

with strong Beijiao, convenient construction, easy to fall off.
Fill with (window) - joint energy saving

单位: mm

侧面图 Profile	品号 Product No.	标准长度 Standard length	封堵缝隙 Sealing Gap	可裁切至 can be cut to
	D10-915	915	22 以内	可适当截短至 合适的长度 can be cut to any desired length
	D10-810	810	18 以内	



安装效果图 Installation diagram