



735

SOLVE EXPERT  
OF SEALING STRIP

吉三吾  
密封条解决专家

昆山吉三吾节能建材有限公司



## 公司简介 Company Profile

吉三吾公司是一家台湾企业，公司成立于2003年，主要生产门窗密封条、装饰材料及家具五金配件为主，产品从设计开发→原料制造→加工→检验QC→包装→物流一贯而成，公司拥有一批专业的技术研发队伍，先进的生产设备，可根据你的不同要求进行设计与开发，业务范围涉及有门窗类、地板类、家具类、汽车类、轮船类、灯饰类、文具类、相框胶条等并向顾客提供以下产品：

- TPE、TPV、ABS、NBR、PVC、PE、PP、POM 相关材质的各式密封胶条
- 软硬共挤产品（如：踢脚线密封条、踢脚线收口条、门套线收口条、密封条、门底刮板）
- 门框挡条、异型条、收口条系列产品
- ABS、PVC 挤出仿金属装饰条、卡条，表面包覆 PET 或纯铝箔材质的金色，银色、玫瑰金…等色
- 软 TPE、TPV、PVC 阻燃密封条、硬 PVC 低发泡木塑挤出产品
- 隐藏式门底自动密封条（适用于木门、金属门、木移门、玻璃门、玻璃移门、外挂式）

吉三吾密封条拥有完整、科学的质量管理体系，通过ISO9001-2008认证，上海质监局产品耐久检测测试，产品获得SGS认证，（8大重金属检测通过）等，多项产品质量认证，使您使用更安心，我们将以平实价格供应为宗旨，以达到工厂与客户双赢的目标。

---

Established in 2003, Kunshan Jisanwu energy conservation materials in building Co., Ltd. is from Taiwan. The main production seal strip, decoration materials and Furniture Hardware Accessories. Product mainly from Product Design and Development → From mix col ranulation → Extrusion or Hardware processing → QC → Packaging, The company has a group of professional R&D teams & advanced production equipment, we will supply Cheapest price and the best quality for the purpose. Used for doors & windows, motors, furniture, lights, Stationery, photo-frames etc. The details of our products include:

- TPE, TPV, ABS, PVC, PVC/NBR, PE, PP, POM extrusion seal strip
- Co-extrusion production of soft and hard composite materials(for example: weather stripping for skirting, end cap (Doorcasing, Clapboard. ), seal strip, a sweep seal...)
- All kinds of PVC shaped and other main extrusion products
- MetalShape cladding available to ABS, PVC(such as trim strip.....)
- Inflaming retarding for TPE, TPV, PVC sealing strip, foamed extrusion products
- Automatic dustproof bar (available to all kinds of door)

We will supply Cheapest price and the best quality for the purpose.

[www.735.com.cn](http://www.735.com.cn)





# 产品的研发及生产工艺流程

## Product Development & Production Process



模具开发  
Mold development



原料加工  
Raw material processing



挤出加工  
Extrusion processing



挤出加工  
Extrusion processing



冲压  
Stamping

# 材质说明 Material Introduction

基础材质 Base material	名称 Name	耐温度 Temperature resistance	特性 Characteristic
PVC	聚氯乙烯 Polyvinyl chloride	70℃~-5℃	PVC 材料具有不易燃性、高强度、耐气候变化性以及优良的几何稳定性。PVC 对氧化剂、还原剂和强酸都有很强的抵抗力，PVC 可分为软质 PVC 和硬质 PVC
TPE	热塑性弹性体 Thermoplastic Elastomer	90℃~-25℃	具有橡胶的高弹性，高强度，高回弹性，又具有环保无毒安全，应用范围广，有优良的着色性，触感柔软，耐候性，抗疲劳性和耐温性，加工性能优越，无须硫化，比重约为 0.95 左右，比水 1.0 还轻，故市场上有人称为“水上漂”，高弹性、高强度、高回弹性、环保无毒的好材料
TPV	热塑性硫化橡胶 Thermoplastic Vulcanizate	120℃~-30℃	比 TPE 的温度更大，更适合用在室外。(以汽车密封条用的较多)
NBR	丁腈橡胶 Nitrile Butadiene Rubbe	70℃~-5℃	不易燃性低于 PVC；但在弹性来比优于 PVC
ABS	丙烯腈-丁二烯-苯乙烯塑料 Acrylonitrile butadiene Styrene copolymers	100℃~-40℃	综合性能较好，冲击强度较高、化学稳定性、电性能良好、柔韧性好，且可表面镀铬，喷漆处理，是加工为装饰性产品的最佳选择，但热变形温度较低，可燃、耐候性较差
PE	聚乙烯 Polyethylene	140℃~-100℃	有优良的耐低温性能（最低使用温度可达 -100~-70℃），化学稳定性好，能耐大多数酸碱的侵蚀（不耐具有氧化性质的酸）。常温下不溶于一般溶剂，吸水性小，电绝缘性优良
PP	聚丙烯 Polypropylene	164℃~170℃	热塑性树脂，通常为半透明无色固体，无臭无毒，耐热、耐腐蚀，制品可用蒸汽消毒是其突出优点。密度小，是最轻的通用塑料。缺点是耐低温冲击性差，较易老化
POM	聚甲醛 Paraformaldehyde	110℃~50℃	刚度高，弹性好，减磨耐磨性好。其力学性能优异，比强度可达 50.5MPa，比刚度可达 2650MPa，与金属十分接近。

基础材质 Base material	名称 Name	密度 Density	特性 Characteristic
铝 Aluminium	铝合金 Aluminium alloy	2.6-2.76	铝合金以铝为基础的合金总称，铝合金密度低，但强度比较高，接近或超过优质钢，塑性好，可加工成各种型材，具有优良的导电性、导热性和抗蚀性，工业上广泛使用，使用量仅次于钢
锌 zinc	锌合金 zinc alloy	6.65-6.75	比重大，铸造性好，可以压铸形状复杂、薄壁的精密件，铸件表面光滑。可进行表面处理，电镀、喷漆。熔化和压铸时不吸铁，不腐蚀压型，不粘模，有很好的常温机械性能和耐磨性，但在高温下抗拉强度和低温下冲击性能都明显下降。
钢 Steel	不锈钢 stainless steel	7.85	不锈钢就是不容易生锈的钢，实际上一部分不锈钢，既有不锈性，又有耐酸性（耐蚀性）不锈钢的不锈性和耐蚀性是由于其表面上富铬氧化膜（钝化膜）的形成，这种不锈性和耐蚀性是相对的，由于不锈钢材具有优异的耐蚀性、成型性、相容性以及很宽温度范围内的强韧性等系列特点，所以在重工业、轻工业、生活用品行业以及建筑装饰等行业中获得广泛的应用。
铜 copper	铜合金 copper alloy	8.96	铜合金以纯铜为基体加入一种或几种其他元素所构成的合金。具有优良的导电性、导热性、延展性和耐蚀性还具有某些特殊机械性能，铜及铜合金对大气和水的抗蚀能力很高。铜是抗磁性物质。

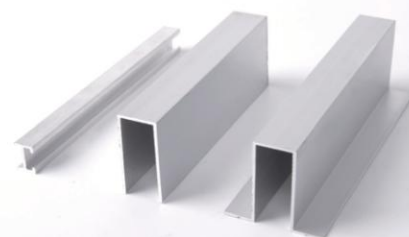



# 目录 Catalog

公司简介 Company Profile	P1
生产工艺流程 Production Process	P2
材质说明 Material Introduction	P3
目录 Catalog	P4

## 密封条简介 Introduction of Sealing Strip P5

- ① D型系列 D Series--P6
- ② 房子型 Pentagonal Series--P7
- ③ 侧边型及其它 Side and other--P8
- ④ 粘贴式 paste type--P9
- ⑤ 玻璃、金属门专用 Glass and metal door--P10

## 装饰条 Decorative trims for furniture P11-12

## 门挡条(线) Stop line for doorframe P13-14

## 踢脚线密封条 END CAP for Baseboard P15

## 门套线收口条 END CAP for Doorcasing P16

## 门底密封条 Dust-proof Strip for Door bottom P17

D1&D11自动隐藏系列 D1 & D11 Auto Hide Series--P18

D17&D18自动隐藏静音系列 D17 & D18 Auto Hide silent Series--P19

D16自动隐藏系列 D16 Auto Hide Series--P20

D12自动隐藏系列 D12 Auto Hide Series series--P21

D10外贴刮板系列 D10 scraper for Door bottom--P22



门挡条  
Stop line  
for doorfi rame

密封条  
Sealing strip

装饰条  
Decorative trims  
for furniture

门线收口条  
END CAP  
for doorcasing

踢脚线  
密封条  
END CAP  
for Baseboard

门底自动密封条  
Dust-proof strip  
for door bottom

门底刮板  
Scraper for  
door bottom



密封条  
Seal strip

## 时尚家居生活必备产品

门框密封条又称消音条也称防震条其最主要功能是让门片与门框接触时降低关门声音、减少灰尘进入门内及延长寿命，保护漆的寿命。广泛适用于家庭、宾馆、医院、商务楼、洁净工程、大型商场等领或，主要起到防尘、挡风、挡光、隔音、隔烟、隔温、挡虫、减少震动等作用。

## Fashion essential household products

**Doorframes seal** Also called Deafen strip Name Quakeproof strip Its most main function is have the gate piece and gate frame contact time falls Lowly closes the sound, and reduced dust enters in the gate and extends Long life, Protective paint life. Which is Widely suitable for the family, the hotel, the hospital, the business building, the pure project, the large-scale market and so on lead, which is main to separate the dust, keep out the wind, separate the light, separate the sound, separate the smoke, separates warm, keep off insect, reduce vibration and so on function.

### 六大强大功能 Six Functional



隔灰尘、冷风



隔暖气外溢



隔冷气外溢



隔蚊虫



隔声音



隔灯光

特别建议：与门底密封条一起使用时，更可节约能源及防冷、暖气外流。

With door bottom seal used together, may save the energy and separate the cold and warm air overflow.



# 嵌入式门框密封条

## Embedded door seal

### 主要适用范围:

适用各种室内门上

### 安装方式:

直接在门阻(框)上开个的凹槽, 将密封条按插入槽即可

### 产品特性:

减少关开门的撞击声, 防震  
防止灰尘、臭气、蚊虫的透入  
延长门的寿命, 减小噪音

### Main application:

suitable for all kinds of indoor

### Installation method:

directly in the door resistance (box) on the opening of the groove, the sealing strip directly into the slot can be

### Product features:

To reduce the impact of the door open shock  
Gum to prevent dust, odor, mosquito penetration  
Extend the life of the door to reduce noise

## 密封条 -D 型

### Seal strip-type D



安装效果图 Installation diagram

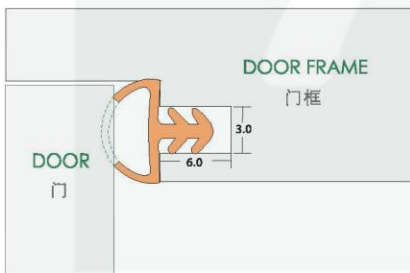

### 标准颜色 Standard color

- 咖啡色 dark brown
- 浅土黄色 shallow yellow
- 本白色 white
- 红樱桃色 red cherry color

以实物为准  
Take the object as the criterion

剖面图 Profile	型号 Item NO.	规格 Spec W*H*F	适用门缝 Applicable gap	适用的档口 Suitable stall	开槽尺寸 Slot size W*D	材质 Material	包装 米/件 Packing M/box
	Q1-36	7.8*3.9*3.7	2-3	8 以上	3*6	PVC 橡塑	300
	Q1-06	8.5*5*3.7	2-4	8.5 以上	3*6	PVC 橡塑	300
	Q1-24	8.5*7*3.8	3-6	8.5 以上	3*6	PVC 橡塑	200
	Q1-38	9*4.5*3.7	2-3	9 以上	3*6	PVC 橡塑	300
	Q1-38-100	10*5*3.7	2.5-4	10 以上	3*6	PVC 橡塑	250
	Q1-10	11.8*5.8*3.7	3-5	12 以上	3*6	PVC 橡塑	200
	Q1-60	10*9*3.7	5-8	10 以上	3*6	PVC 橡塑	150
	Q1-74	9*5*4	3-4	9 以上	3.2*6	PVC 橡塑	300
	Q1-46E	8*3.5*3.7	2-3	8 以上	3*6	TPE 弹性体	300
	Q1-40E	8.5*4.2*3.7	2-3	8.5 以上	3*6	TPE 弹性体	300
	Q1-84E	10*5*3.7	2.5-4	10 以上	3*6	TPE 弹性体	250
	Q1-72E	11.8*5.5*3.7	3-4	12 以上	3*6	TPE 弹性体	200
	Q1-106	8.5*5*3.7	3-4	8.5 以上	3*6	PVC 软硬共挤	2.44M/R

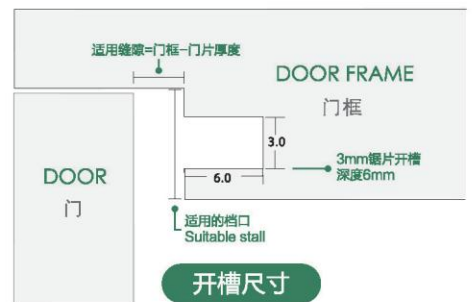

提示: 产品的外型、尺寸、颜色可根据客户需要定做  
建议: 与门底密封条一起使用, 更可节约能源及防冷、暖气外流

Special note: product appearance, size, color can be customized according to customer needs  
Note: if the Door bottom seal is used together with the Doorframe seal, may save the energy and separate

# 密封条 - 房型

## Seal strip-house type

密封条 Seal

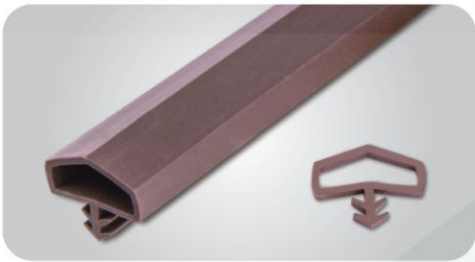

安装效果图 Installation diagram

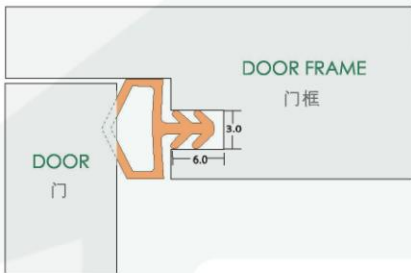

安装效果图 Installation diagram

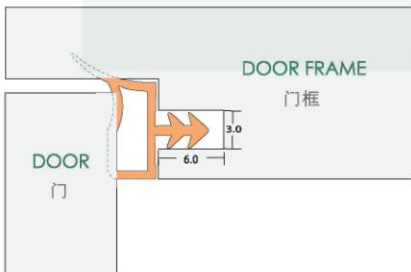

剖面图 Profile	型号 Item NO.	规格 Spec W*H*F	适用门缝 Applicable gap	适用的档口 Suitable stall	开槽尺寸 Slot size W*D	材质 Material	包装 米/件 Packing M/box
	Q1-13	10*4*3.7	2.5-3	10 以上	3*6	PVC 橡塑	250
	<b>HOT 畅销品</b> Q1-25-100	10*5*3.7	2.5-4	10 以上	3*6	PVC 橡塑	250
	<b>HOT 畅销品</b> Q1-25-120	12*6*3.7	3-5	12 以上	3*6	PVC 橡塑	200
	Q1-22	10*6.5*3.7	3-5.5	10 以上	3*6	PVC 橡塑	200
	Q1-19	11*6*4.7	3-5	11 以上	4*6	PVC 橡塑	200
	Q1-14	12*5*3.7	2.5-4	12 以上	3*6	PVC 橡塑	200
	Q1-17	12*8*4	4-7	12 以上	3.2*6	PVC 橡塑	150
	<b>HOT 畅销品</b> Q1-47E	10*5*3.7	2.5-4	10 以上	3*6	TPE 弹性体	250
	Q1-73	15*7*3.7	3-6	15 以上	3*6	PVC 橡塑	150
	<b>HOT 畅销品</b> Q1-49E-120	12*6*3.7	3-5	12 以上	3*6	TPE 弹性体	150
	Q1-JH01	20*7*3.7	4-6	20 以上	3*6	PVC 橡塑	150
	Q1-112	12*6*3.7	4-5	12 以上	3*6	TPE 弹性体	150
	<b>HOT 畅销品</b> Q1-RC01	10*4.5*3.7	3-4	10 以上	3*6	TPE 弹性体	150
	<b>客户专用</b> Q1-ST01	6.7*5.8*3.7	3-5	7 以上	3*6	rubber co-extrusion 橡塑软硬	210 2.44M/R
	Q1-111	10*4.8*3.7	3-4	10 以上	3*6	TPE	150

提示: 产品的外型、尺寸、颜色可根据客户需要定做  
建议: 与门底密封条一起使用, 更可节约能源及防冷、暖气外流

Special note: product appearance, size, color can be customized according to customer needs  
Note: if the Door bottom seal is used together with the Doorframe seal, may save the energy and separate





单位: mm

## 密封条 - 侧边型

### Seal strip-Side type



安装效果图 Installation diagram

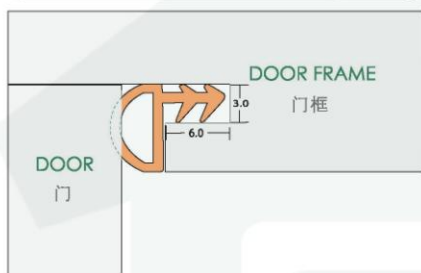

剖面图 Profile	型号 Item NO.	规格 Spec W*H*F	适用门缝 Applicable gap	适用的档口 Suitable stall	开槽尺寸 Slot size W*D	材质 Material	包装米/件 Packing M/box
	<b>HOT畅销品</b> Q1-37	8.5*4.2*3.7	2-3	9 以上	3*6	PVC 橡塑	300
	Q1-53	8.8*4.4*3.6	3-4	9 以上	3*6	橡塑共挤 Rubber co-extrusion	300
	Q1-55	9.5*6.6*3.6	3-5	10 以上	3*6	橡塑共挤 Rubber co-extrusion	300
	Q1-LG01	12*5.5*3.7	3-5	12 以上	3*6	PVC 橡塑	200

单位: mm

## 密封条 - 其他类

### Seal strip-Other class



安装效果图 Installation diagram

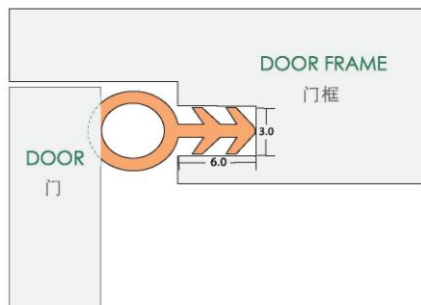

剖面图 Profile	型号 Item NO.	规格 Spec W*H*F	适用门缝 Applicable gap	适用的档口 Suitable stall	开槽尺寸 Slot size W*D	材质 Material	包装米/件 Packing M/box
	Q1-09	5.5*5.5*3.7	3-4.5	5.5 以上	3*6	PVC 橡塑	300
	Q1-71	7*7*4.3	4-6	7 以上	4*6	PVC 橡塑	250
	Q1-96	7*7*2.9	4-6	7 以上	2.5*6	PVC 橡塑	250
	Q1-30E	8.5*5*3.7	3-4	8.5 以上	3*6	PVC 橡塑	200
	Q1-23	9.8*2*3.7	2	12 以上	3*6	PVC 橡塑	300
	Q1-62	20*2*3.7	2	20 以上	3*6	PVC 橡塑	200



提示: 产品的外型、尺寸、颜色可根据客户需要定做

Special note: product appearance, size, color can be customized according to customer needs

# 粘贴式密封条

## Paste sealing strip

### 主要适用范围:

适用各种室内门上

### 安装方式:

自带胶, 直接粘贴即可, 背胶采用进口台湾 3M 或台、德技术合作之高度压敏胶

### 产品特性:

减少关开门的撞击声, 防震防止灰尘、臭气、蚊虫的透入 延长门的寿命, 减小噪音

### Main application:

Suitable for all kinds of indoor

### Installation method:

Installation method: 1 bring glue, paste directly, Beijiao imported Taiwan 3M or Taiwan, German technical cooperation of high pressure sensitive adhesive

### Product features:

To reduce the impact of the door open shock Gum to prevent dust, odor, mosquito penetration Extend the life of the door to reduce noise

剖面图 Profile	型号 Item NO.	规格 Spec W*H*F	适用门缝 Applicable gap	适用的档口 Suitable stall	材质 Material	包装 米/件 Packing M/box
	Q1-11	9*3.5	2-3	9 以上	PVC	500
	Q1-12	11.8*5.5	2-4	12 以上	PVC 橡塑 阻燃	400
	Q1-26	9*5	3-4	9 以上	橡塑共挤 Rubber co-extrusion	600
	Q1-65	12*6	3-5	12 以上	PVC 橡塑 阻燃	200
	Q1-HH01	12*8	5-7	12 以上	PVC	200
	Q1-86	12*5	2-3	12 以上	橡塑	300
	Q1-64	10*2	2	10 以上	橡塑	500
	Q1-67	9*1.5	1.5	9 以上	橡塑	500
	Q1-79	6.6*2	2	6.6 以上	橡塑共挤 Rubber co-extrusion	1600
	Q1-99	16*2	2	16 以上	橡塑	350

## 密封条 - 粘贴式 Seal strip - Paste type



此密封条可一分为二, 撕开单独使用  
This seal can be split in two and torn apart for use alone

### 安装效果图 Installation diagram



### 温馨提示

为获得更好的黏贴效果, 密封条必须粘贴在光滑、清洁、干燥的表面

Tips: to achieve better adhesion effect, the sealing strip must be pasted on a smooth, clean, surface dry surface



### 背胶 Back Glue

现已采用软硬共挤的技术 使产品的粘性更牢固  
Now the use of soft and hard co extrusion technology to make the product more adhesive





单位: mm

## BP 线条 - 玻璃专用

### BP line - glass special



剖面图 Profile	型号 Item NO.	规格 Spce W*H	适用玻璃厚度 Applicable glass thickness	材质 Material	包装米/件 Packing M/Box
	<b>HOT畅销品</b> Q1-58	12.3*5.9	各种厚度 Various thickness	PVC 橡塑	300
	<b>HOT畅销品</b> Q1-29	18.5*10	各种厚度 Various thickness	PVC 发泡 PVC foam	140 2.1M/R
	Q1-113	16.5*10	各种厚度 Various thickness	PVC 发泡 PVC foam	154 2.1M/R
	Q1-114	13.5*10	各种厚度 Various thickness	PVC 发泡 PVC foam	182 2.1M/R

密封条 Seal

## 密封条 - 金属门专用

### Seal strip-metal door special

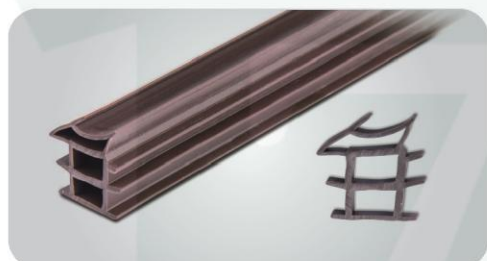

单位: mm

剖面图 Profile	型号 Item NO.	规格 Spce W*H	材质 Material
	Q1-HY01	10*6	橡塑
	Q1-110	13*4	TPE 共挤 TPE co-extrusion
	Q1-TH01	40*3	PVC
	Q1-ALD	21.5*1.6	橡塑共挤 Rubber co-extrusion
	D1-B0385	11*8	PVC TPE
	Q1-87	3.8*4	橡塑共挤 Rubber co-extrusion
	Q1-88	7*4	TPE 弹性体
	Q1-92	9.3*6.2	PVC 橡塑

剖面图 Profile	型号 Item NO.	规格 Spce W*H	材质 Material
	Q1-98	6*8	橡塑共挤 Rubber co-extrusion
	Q1-90	6.5*4	橡塑共挤 Rubber co-extrusion
	Q1-JY01	19.2*9	橡塑共挤 Rubber co-extrusion
	Q1-JY03	18.4*7	橡塑共挤 Rubber co-extrusion
	Q1-WL01	7.5*5.5	橡塑共挤 Rubber co-extrusion
	Q1-XL01	12*4.5	橡塑共挤 Rubber co-extrusion
	Q1-GML01	8.5*3.2	橡塑共挤 Rubber co-extrusion
	Q1-XDL02	4.5*4.5	橡塑共挤 Rubber co-extrusion



提示: 产品的外型、尺寸、颜色可根据客户需要定做

Special note: product appearance, size, color can be customized according to customer needs

“装饰条”具有新颖、雅致、时尚、美观的效果，可广泛用于家庭、办公、星级酒店、娱乐等场所，该产品用于装饰木门或家具，具有凹凸立体感的美术画或装饰图案，增值工艺艺术品的价值，使得高品质木门与优质金属的完美结合，给生活带来无限美感和乐趣。

"Decoration" has novel, elegant, fashionable and beautiful appearance, can be widely used in home, office, hotel, entertainment and other places, the product is used for decorative doors or furniture, has the stereoscopic sense of art or decorative patterns, value-added process the value of art, the perfect combination of high quality and high quality metal doors. Life brings infinite beauty and joy











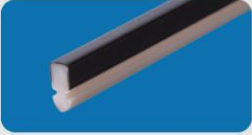
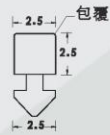

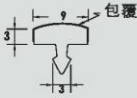

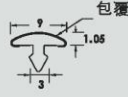
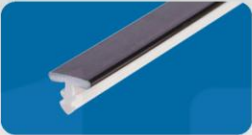
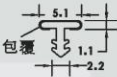
# 门片装饰条、仿金属封边条

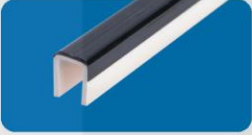
## Decorative trims for furniture

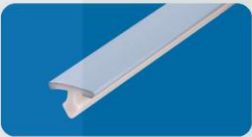
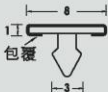
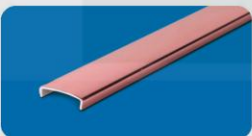



单位: mm

实物图 Material object	剖面图 Profile	型号 Item NO.	规格 Spec W*H*F	开槽尺寸 Slot size W*D	材质 Material	标准长度 / 每支 Standard length/Each	包装 支/件 Packing M/box
		Q1-35	2.5*2.5*2.5	2*6	PET+PVC (加工热贴)	2.2/2.5 (可订制长度) customizable length	250
		Q1-45	9*3*3	2.5*6	PET+PVC (加工热贴)	2.2/2.5 (可订制长度) customizable length	400
		Q1-54	9*1.05*3	2.5*6	PET+PVC (加工热贴)	2.2/2.5 (可订制长度) customizable length	400
		Q1-56	5.1*1.1*2.2	1.8*5	PET+PVC (加工热贴)	2.2/2.5 (可订制长度) customizable length	600
		Q1-108	5*4	4.8*4	PVC 硬质	2.2/2.5 (可订制长度) customizable length	805
		Q1-69	7*7		PET+PVC (加工热贴)	2.2/2.5 (可订制长度) customizable length	400
		Q1-75	8*1*3	2.5*6	PET+PVC、ABS 底材 (加工热贴)	2.2/2.5 (可订制长度) customizable length	500
		Q1-104	19*5.2		PET+PVC (加工热贴)	2.2/2.5 (可订制长度) customizable length	

仅供参考 For reference only



### 标准颜色 Standard color

	
消银色 Silver	金黄色 Golden
	
黑色 Black	亮银色 Bright silver
	
不锈钢拉丝 Stainless steel	玫瑰金色 Rose Gold

以实物为准  
Take the object as the criterion



提示: 产品的外型、尺寸、颜色可根据客户需要定做

Special note: product appearance, size, color can be customized according to customer needs

## 塑料替代木料

门挡条，镶在门套中间，用来挡着门，具有防风、防尘，密封隔音的效果，传统上使用的门挡是由木料裁切加工而成，处理工序烦琐，耗时、占地面积大，木料吸湿易变形，开裂，发霉等问题，塑料门档条都能解决。塑料门档条可直接使用，减少加工工序，降低人工成本，具有不变形、不开裂、防潮、环保、坚固耐用等特点，施工方便，易于安装，交货迅速，是您理想中的选择。

Stop line for doorframe, inlaid in the middle door, to the door, with wind, dust, noise sealing effect, the traditional use of the door stop, It is made of wood cutting, and the processing procedure is tedious, time consuming, large area, moisture absorption, dehiscence, dehiscence, mouldy and so on. stop line for doorframer can be solved. The plastic door gear can be used directly to reduce the processing procedure and reduce the labor cost. It has no deformation, no cracking and prevention. Moisture, environmental protection, durable and other characteristics, convenient construction, easy to install, rapid delivery, is your ideal choice



二次加工、人工、设备投入多



吸水易变形



占地，使用空间大

木料 塑料



占地面积小



吸水不变型



直接使用，无需二次加工



# 门挡条(线)

## Stop line for doorframe

### 主要适用范围:

适用于 PVC 免漆门

### 安装方式:

直接卡在门框上

### 产品特性与增加工厂优势:

1. 表面材与底材贴合使用年限更长久
2. 去除长期人工费及社保费不断上涨
3. 采用 735 门挡条一体成形, 损耗最小
4. 使用木料加工上占据很大的空间, 使工厂空间更有效应用
5. 没有木工机器的损坏及损耗修理的费用
6. 减少工伤
7. 减少人员流动性
8. 施工方便, 交货迅速

### Main application:

applicable to PVC paint free door



### Installation method:

direct card on the door frame

### Product characteristics and increase plant advantage:

- 1 the surface material and the base material lamination service life is longer
- 2 removal of long-term labor costs and social security costs continue to rise
- 3 the use of a total of 735 doors, forming a minimum loss
- 4 the use of wood processing occupy a lot of space to make more effective use of factory space
- 5 there is no cost of repair and maintenance of woodworking machines
- 6 reduce injury
- 7 reduce mobility
- 8 convenient construction, prompt delivery

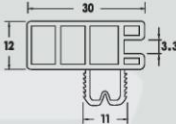
单位: mm

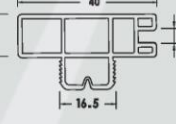
实物图 Material object	剖面图 Profile	型号 Item NO.	规格 Size W*H*F	材质 Material	标准长度 / 每支 Standard length/Eacha	包装 支 / 件 Packing M/box
		Q1-15	30*12	PVC 硬质 PVC hard	2.44M (可订制长度) customizable length	60
		Q1-20	40*12	PVC 硬质 PVC hard	2.44M (可订制长度) customizable length	50

### 安装效果图 Installation diagram

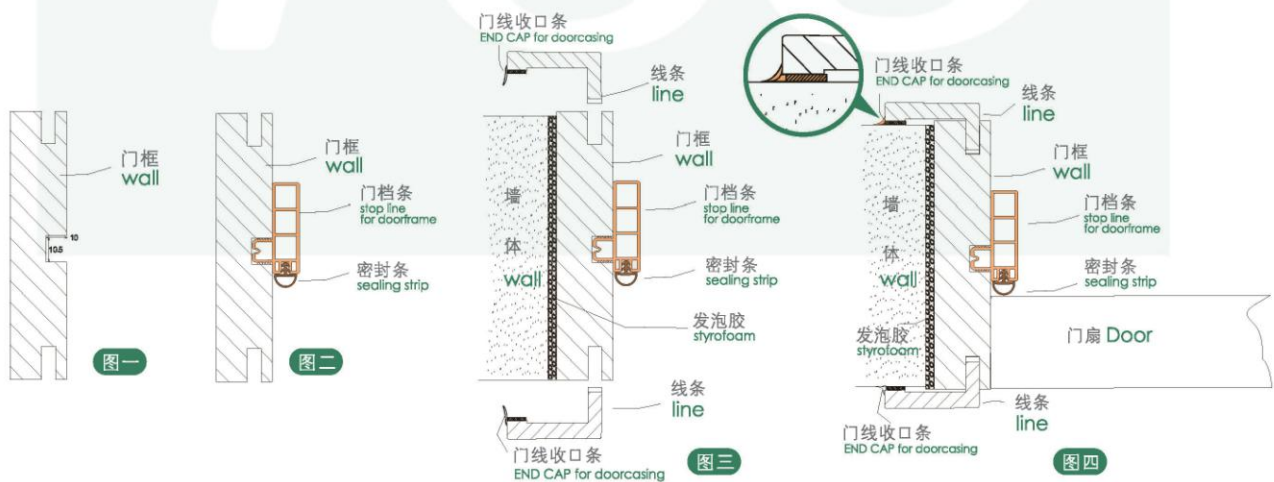

提示: 产品的外型、尺寸、颜色可根据客户需要定做

Special note: product appearance, size, color can be customized according to customer needs

# 踢脚线密封条

## END CAP for Baseboard

### 主要适用范围:

适用各种踢脚线上

### 安装方式:

直接粘贴在使用部位或开宽 2.2mm 深 5mm 的凹槽

### 产品特性:

1. 解决地板热胀冷缩问题
2. 应用于厨卫、墙缝防水防霉
3. 施工方便, 交货迅速
4. 易清洁、美观漂亮

### Main application:

suitable for all kinds of skirting

### Installation method:

directly paste in the use of parts or open wide 2.2mm deep groove 5mm

### Product features:

- 1 to solve the problem of thermal expansion and contraction
- 2 used in kitchen and bathroom, waterproof wall
- 3 convenient construction, prompt delivery
- 4 easy to clean, beautiful appearance



单位: mm

实物图 Material object	剖面图 Profile	型号 Item NO.	规格 Spec W*H*F	开槽尺寸 Slot size W*H	材质 Material	标准长度 / 每支 Standard length/Each	包装 支 / 件 Packing M/box
		Q1-28	7.5*4.5*2.3	2*6	PVC 共挤 soft-rigid co-extrusion	2.44M (可订制长度) customizable length	400
		Q1-18	8.2*5*2.5	2.2*6	PVC 共挤 soft-rigid co-extrusion	2.44M (可订制长度) customizable length	400
		Q1-52	7.8*7*2.5	2.2*6	PVC 共挤 soft-rigid co-extrusion	2.44M (可订制长度) customizable length	300
		Q1-78	12*5*2.35	2*6	橡塑共挤 Rubber co-extrusion	2.44M (可订制长度) customizable length	224
		Q1-81	9*5		橡塑共挤 Rubber co-extrusion	2.44M (可订制长度) customizable length	272

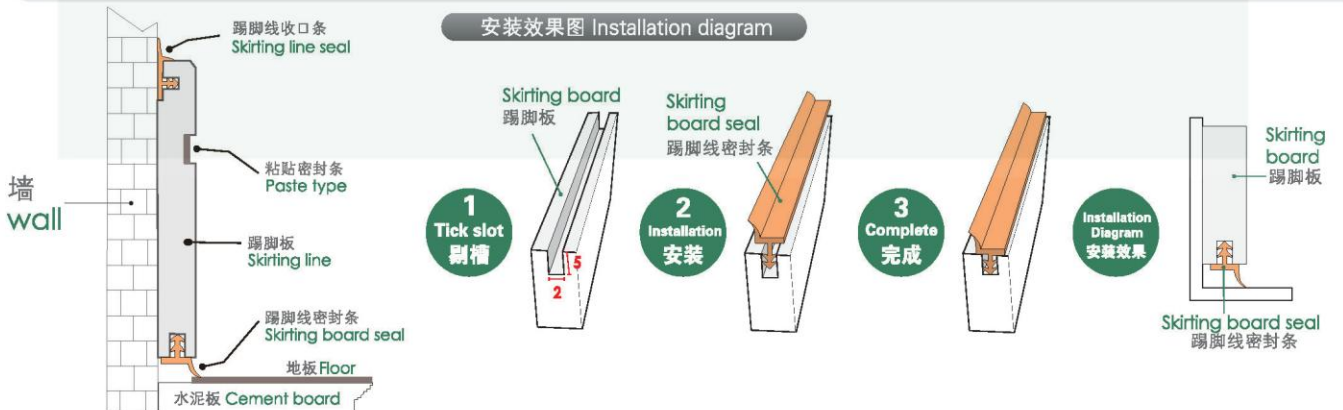

提示: 产品的外型、尺寸、颜色可根据客户需要定做  
建议: 与踢脚线收口条一起使用效果更佳

Special note: product appearance, size, color can be customized according to customer needs  
Suggestion: baseboard shut up together with better results





# 门套线、踢脚板（上）收口条

## END CAP for Doorcasing

### 主要适用范围:

适用各种门套线、踢脚线、厨柜上

### 安装方式:

直接粘贴在使用部位或开宽 2.2mm 深 5mm 的凹槽

### 产品特性:

1. 施工方便、交货迅速
2. 易清洁、美观漂亮
3. 解决打硅胶不雅问题，
4. 解决缝隙发霉问题，防潮防霉

### Main application:

applicable to all kinds of line, baseboard, cabinet

### Installation method:

directly paste in the use of parts or open wide 2.2mm deep groove 5mm Product

### Product features:

- 1 convenient construction, prompt delivery
- 2 easy to clean, beautiful appearance
- 3 to solve the problem of silicone gel,
- 4 to solve the problem of cracks in the mold, moisture-proof mold



门套线收口条

踢脚线密封胶条 Skirting strip

单位: mm

实物图 Material object	剖面图 Profile	型号 Item NO.	规格 Spec W*H*F	材质 Material	标准长度 / 每支 Standard length/Each	包装 支/件 Packing M/box
		Q1-78	12*5*2.4	橡塑共挤 Rubber co-extrusion	2.44M (可订制长度) customizable length	224
		Q1-81	9*5	橡塑共挤 Rubber co-extrusion	2.44M (可订制长度) customizable length	272

### 安装效果图 Installation diagram



图一



图二



提示: 产品的外型、尺寸、颜色可根据客户需要定做  
建议: 与踢脚线密封胶条一起使用效果更佳

Special note: product appearance, size, color can be customized according to customer needs  
Recommendation: with the use of skirting line seal effect is better

门底自动密封条是为了密封门底与地面或门槛之间的缝隙而设计的，当门打开时，密封条会自动升高地面，当门关闭时，密封条会自动降下来，起到密封作用，隐藏式的设计不影响门的外观，不妨碍门的开与关，也不会磨损地面。适用于木质门、金属门、钢木门的门底安装，可起到隔音、隔温、挡尘的效果。

The automatic bottom door seal is to seal the gap between the bottom of the door and the ground or the threshold of the design, when the door is opened, the seal will automatically rise from the ground, when the door is closed, the seal will automatically drop down, plays a role in sealing, the hidden design does not affect the appearance of the door, do not interfere with the door open and, don't wear the ground. The utility model is suitable for the installation of the wooden door, the steel door and the steel door, and can play the functions of sound insulation, temperature isolation and dust control





# 门底自动密封条--D1 & D11隐藏系列

## Auto hide dustproof strip for door bottom--D1 & D11 series

### 主要适用范围:

适用于木质门、金属门、钢木门……

### 标准配置:

1根防尘条、配件包可选配件包1或者配件包3, 或无配件(调整钮可选铜头)

### 安装方法:

将自动门底密封条嵌入槽中, 两边顶端用随附包装所提供的固定挡片固定

### Main application:

Suitable for wooden door, metal door, steel door……



### Standard configuration:

1 dust bars, accessories package optional accessories package 1 or accessories package of 3, or spare parts (adjustable button optional copper head)

### Installation method:

The automatic door bottom sealing strip is embedded in the groove, and both sides of the top end are fixed with the fixed retaining plate provided by the accompanying package

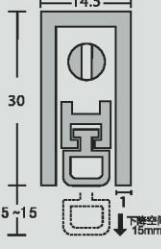
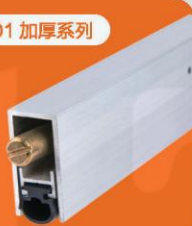
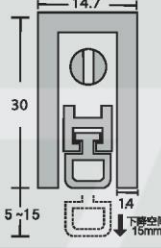
单位: mm

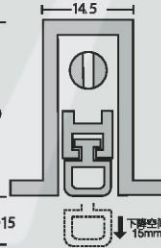
型号 Item NO.	实物图 Material object	剖面图 Profile	品号 Product No.	适用门片的规格 Specification for door panels	长度范围 length	密封材质 Sealing material	封堵缝隙 Sealing Gap
<b>D1 系列</b>			D1-25 D1-66 D1-85 D1-100 D1-120 D1-150 D1-185	250~330 330~660 660~850 660~1000 1000~1200 1200~1500 1500~1850	250~1850 (可截取任意长度) Interception Arbitrary length	PVC TPE	15 以内
<b>D1 加厚系列</b>			D1-25H D1-66H D1-85H D1-100H D1-120H D1-150H D1-185H	250~330 330~660 660~850 660~1000 1000~1200 1200~1500 1500~1850	250~1850 (可截取任意长度) Interception Arbitrary length	PVC TPE	15 以内
<b>D11 系列</b>			D11-25 D11-66 D11-85 D11-100 D11-120 D11-150 D11-185	250~330 330~660 660~850 660~1000 1000~1200 1200~1500 1500~1850	250~1850 (可截取任意长度) Interception Arbitrary length	PVC TPE	15 以内



Accessories-1 配件包-1



Accessories-3 配件包-3

材质: 304 不锈钢 / SPCC 铁镀镍  
Material: 304 stainless steel / SPCC iron plating



提示: 产品的外型、尺寸、颜色可根据客户需要定做  
建议: 与门框密封条一起使用, 更可节约能源及防冷、暖气外流

Special note: product appearance, size, color can be customized according to customer needs  
Note: The utility model can be used together with a door frame sealing strip, and the utility model can save energy and prevent cold and heat from flowing out

# 门底自动密封条--D17 & D18静音隐藏系列

Auto hide dustproof strip for door bottom--D17 & D18 Silent series

**专利  
新品**

**主要适用范围:**

适用于木质门、金属门、钢木门……

**标准配置:**

1 根防尘条 (调整钮纯铜头)、  
配件包可选 304 不锈钢或 SPCC 铁镀镍

**安装方法:**

将自动门底密封条嵌入槽中,  
两边顶端用随附包装所提供的固定挡片固定

**Main application:**

Suitable for wooden door, metal door, steel door……



**Standard configuration:**

1 dust bars, accessory kit optional 304 stainless steel or SPCC iron nickel-plated

**Installation method:**

The automatic door bottom sealing strip is embedded in the groove,  
and both sides of the top end are fixed with the fixed retaining plate provided  
by the accompanying package

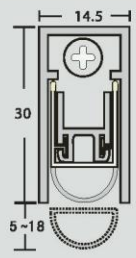
单位: mm

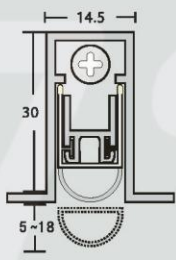
型号 Item NO.	实物图 Material object	剖面图 Profile	品号 Product No.	适用门片的规格 Specification for door panels	长度范围 length	密封材质 Sealing material	封堵缝隙 Sealing Gap
D17 系列			D17-50	340-500	340~1500 (可截取任意长度) Interception Arbitrary length	橡塑共挤 Rubber co-extrusion	18 以内
			D17-65	500-650			
			D17-85	650-850			
			D17-100	850-1000			
			D17-120	1000-1200			
			D17-135	1200-1350			
D17-150	1350-1500						
D18 系列			D18-50	340-500	340~1500 (可截取任意长度) Interception Arbitrary length	橡塑共挤 Rubber co-extrusion	18 以内
			D18-65	500-650			
			D18-85	650-850			
			D18-100	850-1000			
			D18-120	1000-1200			
			D17-135	1200-1305			
D17-150	1305-1500						



**Accessories-3 配件包-3**

**标配配件**

Marking accessories:

材质: 304 不锈钢 / SPCC 铁镀镍

Material: 304 stainless steel/SPCC iron plating

标配

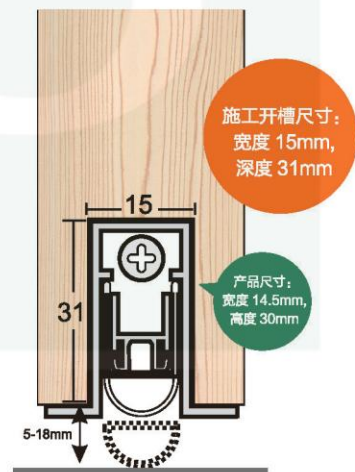

提示: 产品的外型、尺寸、颜色可根据客户需要定做  
建议: 与门框密封条一起使用, 更可节约能源及防冷、暖气外流  
Special note: product appearance, size, color can be customized according to customer needs  
Note: The utility model can be used together with a door frame sealing strip, and the utility model can save energy and prevent cold and heat from flowing out





# 门底自动密封条--D16隐藏系列

## Auto hide dustproof strip for door bottom--D16 series

### 主要适用范围:

适用于木质门、金属门、钢木门……

### 标准配置:

1根防尘条、配件包  
(不锈钢档片2片, 不锈钢螺丝\*2)

### 安装方法:

将自动门底密封条嵌入槽中,  
两边顶端用随附包装所提供的固定挡片固定

### Main application:

Suitable for wooden door, metal door, steel door……

### Standard configuration:

1 dust bars, accessories package (stainless steel 2 pieces, stainless steel screws \*2)

### Installation method:

automatic door bottom sealing strip embedded in the groove, both sides of the top with the accompanying packaging provided by fixed retaining plate fixed

单位: mm

型号 Item NO.	实物图 Material object	剖面图 Profile	品号 Product No.	适用门片的规格 Specification for door panels	长度范围 length	密封材质 Sealing material	封堵缝隙 Sealing Gap
			D16-50	385-500			
			D16-65	500-650			
			D16-80	650-800	385-950	TPE	15 以内
			D16-95	800-950			

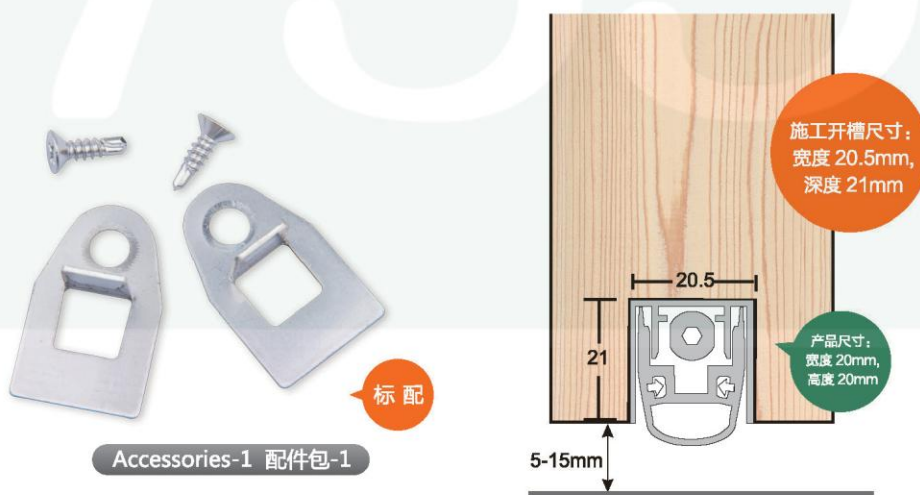

提示: 产品的外型、尺寸、颜色可根据客户需要定做  
建议: 与门框密封条一起使用, 更可节约能源及防冷、暖气外流  
Special note: product appearance, size, color can be customized according to customer needs  
Note: The utility model can be used together with a door frame sealing strip, and the utility model can save energy and prevent cold and heat from flowing out

## 门底自动密封条--D12隐藏系列

Auto hide dustproof strip for door bottom--D12 series

**主要适用范围:**

适用于木质门、金属门、钢木门……

**装饰盖颜色:**

白色, 咖啡色, 红棕色、灰色

**安装方法:**

需在门底中间加工一条 10.5mmX19mm 的嵌槽, U 型铝型材固定在槽中, H 型插入 U 型材中左右装饰盖盖紧, 调整钮至理想位置

**Main application:**

Suitable for wooden door, metal door, steel door……

**Decorative cover color:**

white, brown, red brown, gray

**Installation method:**

to insert groove intermediate processing a 10.5mmX19mm at the bottom of the door, U type aluminum profile is fixed in the groove, H insertion of U profiles, or decorative cover tightly, the adjusting knob to the desired position

单位: mm

型号 Item NO.	实物图 Material object	剖面图 Profile	品号 Product No.	适用门片的规格 Specification for door panels	长度范围 length	密封材质 Sealing material	封堵缝隙 Sealing Gap
			D12-71	520~710	520~1200 (可截取任意长度) Interception Arbitrary length	TPE	15 以内
			D12-90	710~900			
			D12-120	900~1200			



Accessories-1 配件包-1

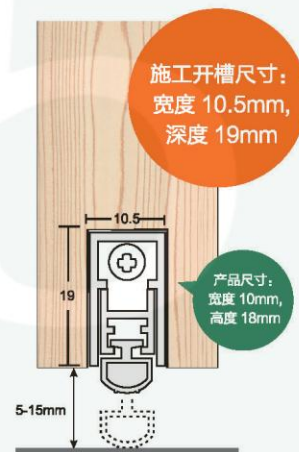



# 外贴刮板--D10系列

## Scraper for Door bottom

### 主要适用范围:

室内门、钢制门、纱窗门、推拉门……

### 标准位置:

可在门的底部外侧或内侧或推拉门的周边安装

### 安装方法:

自带胶，直接粘贴也可以用螺钉安装。  
按门(窗)的宽度截锯密封胶条

### 材质:

采改性 PVC 材质，利用软、硬共挤制成后  
加发泡 PE 背胶

### 特性:

附强力背胶、施工方便、不易脱落。  
填满门(窗)缝 --- 节约能源

### Main application:

indoor doors, steel doors, screen doors, sliding doors.....

### installation position:

can be installed on the outside or inside of the door or  
theperiphery of the sliding door

### installation:

With glue, can also be used directly to install screws.  
Cut the sealing strip according to the width of the door (window)

### Material:

adopt modified PVC material, the use of soft and hard coextrusion  
made after adding foaming adhesive PE

### Characteristics:

with strong Beijiao, convenient construction, easy to fall off.  
Fill with (window) - joint energy saving

单位: mm

侧面图 Profile	品号 Product No.	标准长度 Standard length	封堵缝隙 Sealing Gap	可裁切至 can be cut to
	D10-915	915	22 以内	可适当截短至 合适的长度 can be cut to any desired length
	D10-810	810	18 以内	



安装效果图 Installation diagram



# 735

## 昆山吉三吾节能建材有限公司

**总部:** 江苏省昆山市花桥镇徐公桥路338号36幢 邮编: 215332

**工厂:** 江苏省昆山市花桥镇蓬青路101号 邮编: 215332

**电话:** 0512-36904735 (办公室)、0512-36905719 (工厂)

**传真:** 0512-36905347 (办公室)、0512-36904719 (工厂)

**E-mail:** 308@735.com.cn

**Kunshan Jisanwu energy conservation materials in buildings Co., Ltd.**

**HQ:** Building 36, No.338, Xugongqiao Road, Huaqiao Township,  
Kunshan City, Jiangsu Province, China . 215332

**FTY:** No.101, Pengqing Road, Huaqiao Township, Kunshan City,  
Jiangsu Province,China . 215332

**TEL:** +86-512-36904735 (Office)、+86-512-36905719 (FTY.)

**FAX:** +86-512-36905347 (Office)、+86-512-36904719 (FTY.)

[www.735.com.cn](http://www.735.com.cn)



735网站



735密封条